



Advanced 3D Printing Klipper Kit Installation Guide

Kit contents

- 1. Panel Due Harness.** Used to connect Raspberry PI (RASPI) running Klipper to your Troodon printer Panel Due (controller) board via Panel Due board connector. This harness has a 5x2 Dupont connector on the RASPI end – this one will be connected to the RASPI GPIO pins. The other end of the harness has 2 Dupont connectors: 3x3 data connector to be connected to the Panel Due board connector of your printer and 2-pin power connector that will power your RASPI. This one will be connected to the cable that was (previously) connected to the Panel Due board connector. **Please note that colors of the wires may vary.**
- 2. Accelerometer harness.** Used to connect an accelerometer to your RASPI for the purpose of acceleration tuning. This installation of this harness is optional and is required only if/when you want to tune acceleration for high-speed printing. This harness has a 4x2 Dupont connector on the RASPI end – this one will be connected to the RASPI GPIO pins. The other side has the accelerometer board pre-connected. **Please note that colors of the wires may vary.**



Both harnesses have an “arrow” (triangle) sign on one side of every connector. These arrows indicate the exact placement of the connector on the RASPI GPIO pin board or Panel Due board or cable. Please locate the arrows and if required highlight with a white marker.

- 3. RASPI camera.** Stock RASPI camera with ribbon cable and additional extension ribbon cable (stock cable may be too short for the application). The cable will connect to the camera slot of your RASPI board. Camera is used for remote monitoring of your prints and is also optional (highly recommended). You can opt not to install it or install a 3rd party camera of your choice, however the included camera suits Troodon printers very well.
- 4. SD Card.** Micro SD (HC) card with pre-configured Mainsail and Klipper image for your printer (Troodon 300 or 400). The card needs to be inserted into your RASPI card reader slot. It also (optionally) contains settings allowing it to connect to your Wi-Fi network.



We recommend creating a backup copy of the card image using PC card reader and Win32DiskImager or similar. Note that the card contains Linux OS image and will produce some warning message when inserted into your Windows computer. This is normal and can be ignored. Please do not attempt to update or copy this card manually.

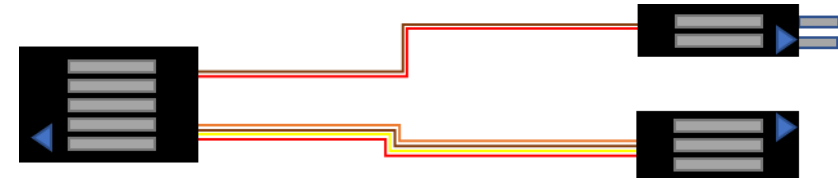

Panel Due Harness

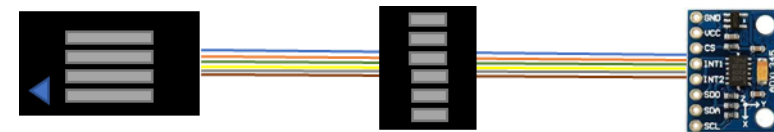

Accelerometer Harness



RASPI Camera and extension cable



SD card

What you need

1. **Raspberry PI Board (RASPI).** Both RASPI Model 3 and 4 will work.



This installation does not require any case or fan; however, we recommend placing heatsinks on your RASPI board components. We also recommend an optional RASPI power supply to test your RASPI before installing into the printer.

2. **USB cable.** Must be USB (A to B) data cable to connect RASPI to your printer mainboard (Duet). Length should be at least 6 inches/15cm or longer.

3. **Printer.** Stock Troodon printer (300 or 400mm model) with optional DDE upgrade.



We recommend ensuring that the printer is operational in its stock configuration before commencing the installation of the kit.

4. **Computer.** Windows, Mac or Linux workstation connected to your network, with card reader, web browser and terminal software/SSH client (Windows SSH, Mac Terminal, Putty, etc.).

5. **Tools.** Screwdriver, tweezers, etc.



RASPI Board



USB Cable



Printer

Installation process overview

Assemble and Set Up Printer.

Your printer should be assembled and fully operational before the installation of the kit. This manual does not cover assembly and initial set up of Troodon 300 or 400; it is simply listed here as a prerequisite step.

Step 1. Prepare Raspberry PI.

This step gets your RASPI ready to be installed into the printer. It involves connecting Panel Due and Accelerometer harnesses to your RASPI board, connecting provided RASPI camera and verifying that your RASPI is working properly before being connected to your printer.

Step 2. Connect Raspberry PI to the printer.

This step involves opening your printer, disconnecting Panel Due board connector, connecting RASPI Panel Due harness data and power connectors and connecting RASPI to the printer mainboard via USB.



This step should be done strictly with the printer powered off and disconnected from the main power.

Step 3. Configure Klipper.

This step involves connecting to your RASPI remotely from your browser and flashing Klipper firmware to the printer mainboard (Duet).



This step does not involve installation of updates to your RASPI . Some of these updates may require configuration changes that are not covered in this manual. There is an automatic update script built in under the "Settings – Machine" tab.

Step 4. Finalize Installation.

This step involves routing accelerometer and camera cables to the main printer enclosure, mounting RASPI board inside the electronics enclosure of the printer and closing the front panel.

Test Printer Operations and Install Accelerometer and Tune Acceleration.

After successful completion of steps 1-4 above, you may want to test printer operations (pre-heating, loading filament, homing, bed levelling) and/or install accelerometer on your print head and perform acceleration tuning to further improve your print quality and speed.



These steps will be covered in a separate guide.

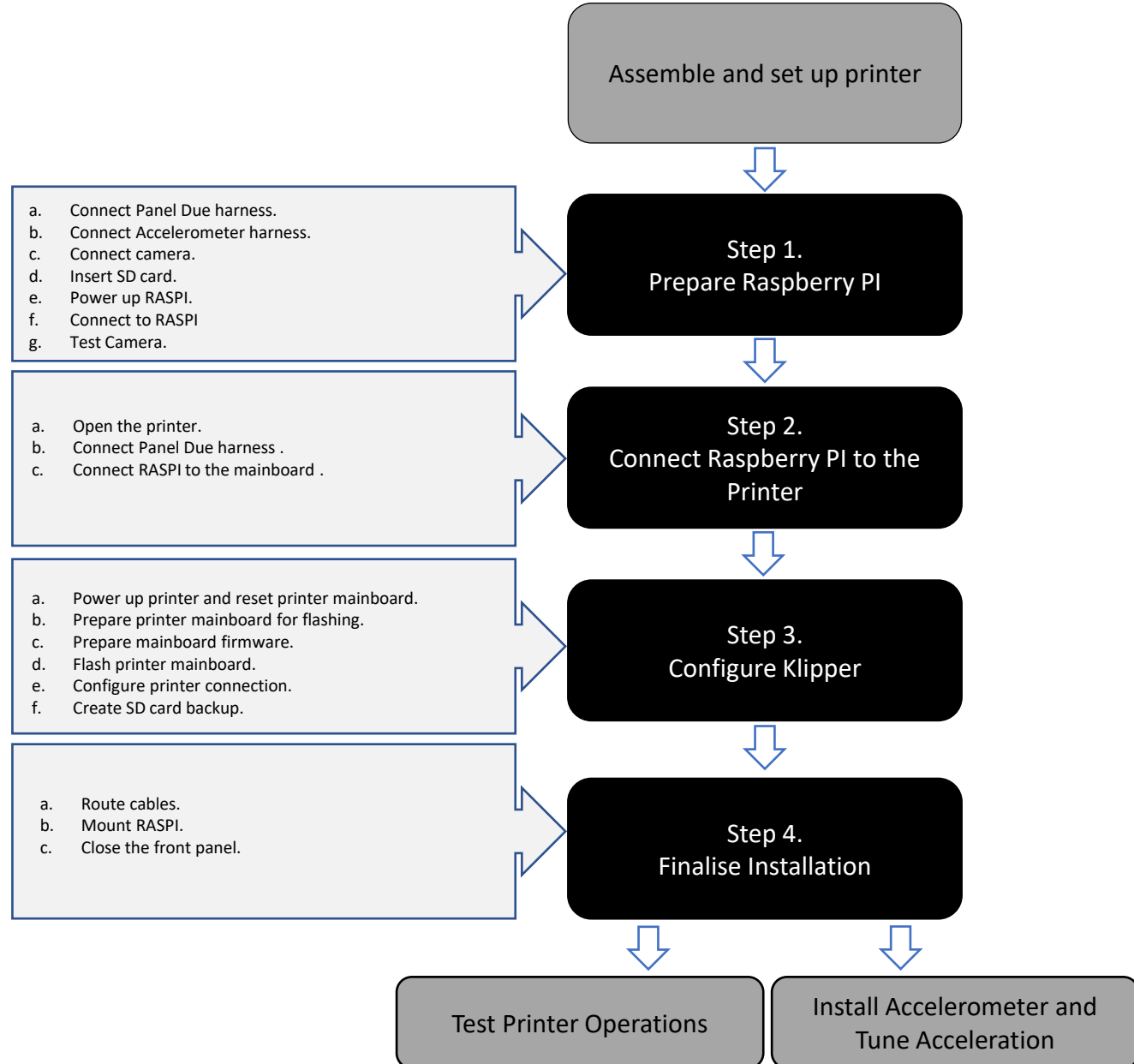

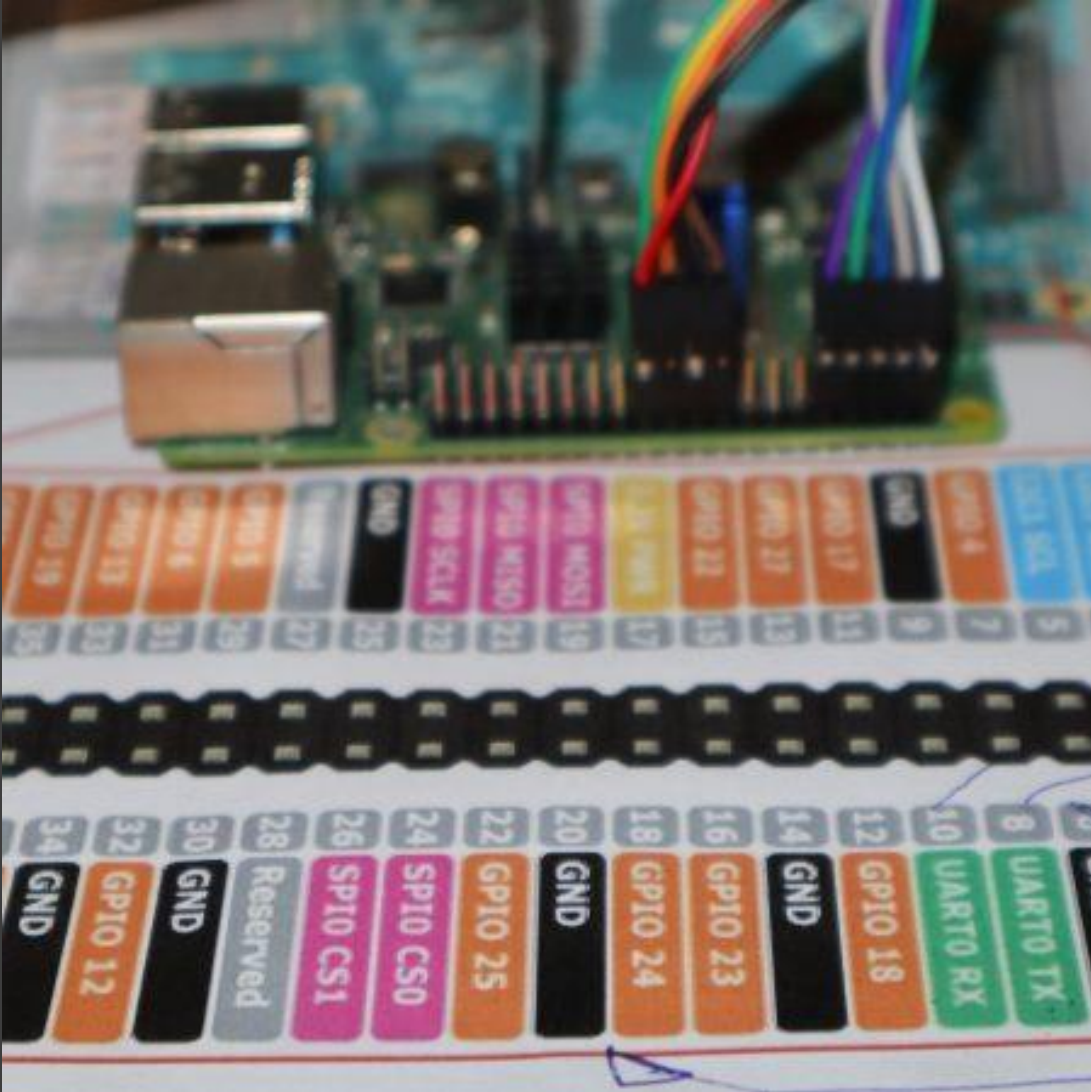

Step 1. Prepare Raspberry Pi

1.a – 1.d: Get RASPI ready

a. Connect Panel Due harness.

Connect Panel Due harness (the end with a single 5x2 Dupont connector) to pins## 1 – 10 on the RASPI GPIO board. These are highlighted with the **red** box on [Diagram 1.1](#) (courtesy of [raspberrypi.org](#)). To connect the Panel Due harness properly, please locate an arrow (triangle) on the 5x2 Dupont connector of the harness and ensure that it is connected to the pin# 2 of the GPIO board (highlighted by the red arrow on the [Diagram 1.1](#)). In other words, Panel Due harness connector should cover top (from the SD card slot end) 5 rows of pins of your RASPI GPIO board.

b. Connect Accelerometer harness.

Connect Accelerometer harness (the end with 4x2 Dupont connector) to pins## 17 – 24 on the RASPI GPIO board. These are highlighted with the **green** box on [Diagram 1.1](#). To connect the Accelerometer harness properly, please locate an arrow (triangle) on the 4x2 Dupont connector of the harness and ensure that it is connected to the pin# 18 of the GPIO board (highlighted by the green arrow on the [Diagram 1.1](#)). In other words, there should be 3 rows of free pins (total of 6 free pins) between the Panel Due and Accelerometer connectors on the GPIO board.

c. Connect camera.

If required, replace stock ribbon cable on the camera with the extended one. Camera ribbon cable should be connected to the camera slot on the RASPI board. There are plenty of videos and manuals available to guide you through the process. We should only note that the contact plates on the camera ribbon cable should be facing micro-HDMI connectors side of RASPI when inserted into the slot as highlighted by the **yellow** arrow on [Diagram 1.1](#).

d. Insert SD card.

Before inserting provided micro-SD card into your RASPI, please ensure that the Klipper image on the card contains correct Wi-Fi settings (SSID and security token/password) for your Wi-Fi network. Your kit may have it already pre-configured; otherwise please insert the SD card into the SD card reader on your PC and enter your Wi-Fi settings into the “mainsailos-wpa-suppllicant.txt” file. There are plenty of videos and manuals available to guide you through this procedure.

Finally, insert provided micro-SD card into the SD card slot of your RASPI.

Diagram 1.2 illustrates the end result of these steps. Arrows that indicate proper positions of connectors are highlighted by **red** and **green** circles. Please note that “Acc” (Accelerometer) and “Pdue” (Panel Due) markings on the connectors are for illustration purposes and will not appear on your kit. Please also note that RASPI board in [Diagram 1.2](#) has heat sinks installed, please refer to your RASPI manual for the heat sinks installation instructions.

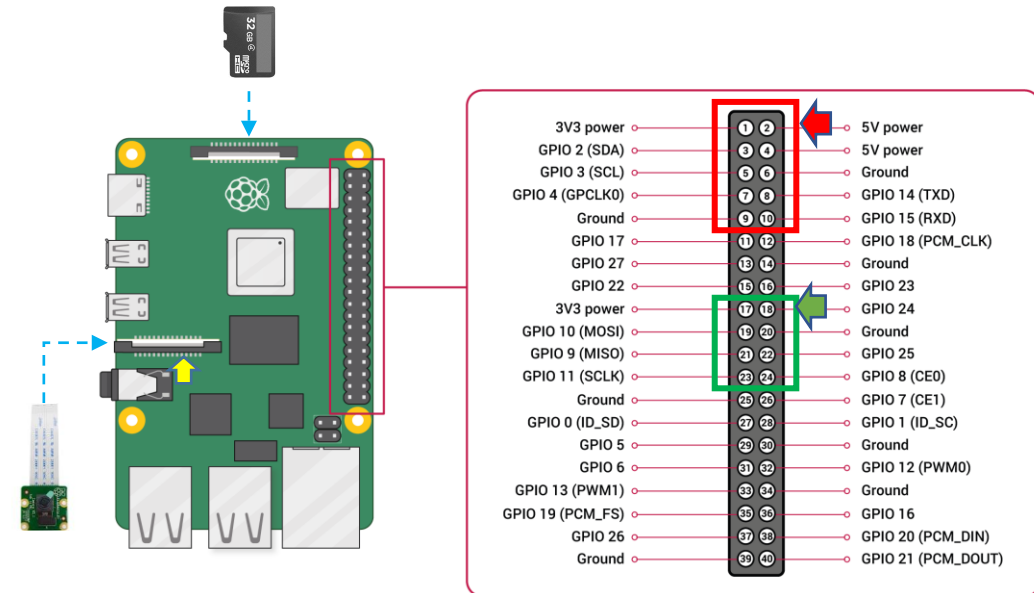

Diagram 1.1

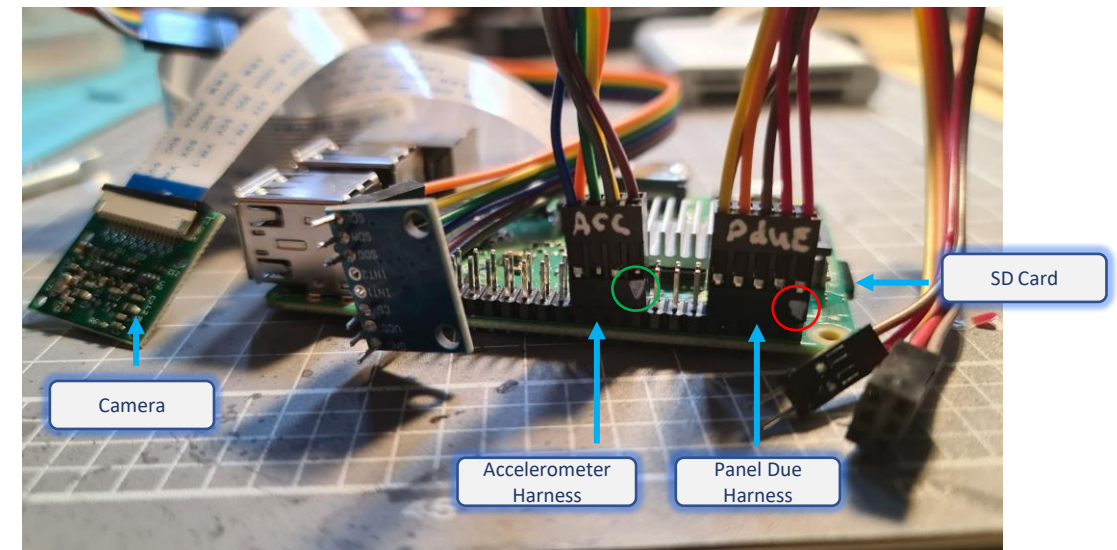

Diagram 1.2

1.e – 1.g: Verify RASPI is working

e. Power up RASPI.

Power up your RASPI using compatible power supply. We recommend using official Raspberry power supply to avoid damage to your board. Allow couple of minutes for RASPI to boot up for the first time and connect to your WiFi network.

f. Connect to RASPI.

Find out the IP address of your RASPI – the best way to do it is to access DHCP status page of your router and/or WiFi access point and look for a newly assigned IP address. [Diagram 1.3](#) provides an example or that – the exact configuration depends on the make and model of your router/WiFi Access point. Depending on your DHCP settings it may be named Troodon300 or Troodon400. You may also try to use **ping Troodon300** or **ping Torrdon400** command to find out the IP address.

Once you know the IP address, type it in your browser and you should see the Klipper (Mainsail) dashboard page, similar to the one on [Diagram 1.4](#).



If you cannot reach this page or don't have a proper IP address assigned, please check your WiFi settings (Step 1.d). You may also try to connect your RASPI to your router with network cable.

g. Test camera.

If your dashboard page does not have a Webcam widget visible, click Settings, then Interface on the left side menu and enable "Webcam" under "Dashboard" options ([Diagram 1.5](#)). You may now click back on the Dashboard - if you have an image from your Webcam, it has been properly connected, otherwise please check your camera connection (Step 1.c). You may need to refresh your browser or restart RASPI by pressing System menu (the top right button labelled with 3 dots on the Dashboard page) and selecting "Host - Reboot".



Now your RASPI is ready to be installed into the printer. Disconnect the power supply as it will not be required for the installation.

Host Label	MAC Address	IP Address
DalimAC	00:06:8b:55:11:86	192.168.1.24
octopi	dc:a6:32:98:f0:4b	192.168.1.25
Troodon300	b8:27:eb:99:e2:ba	192.168.1.26

Diagram 1.3

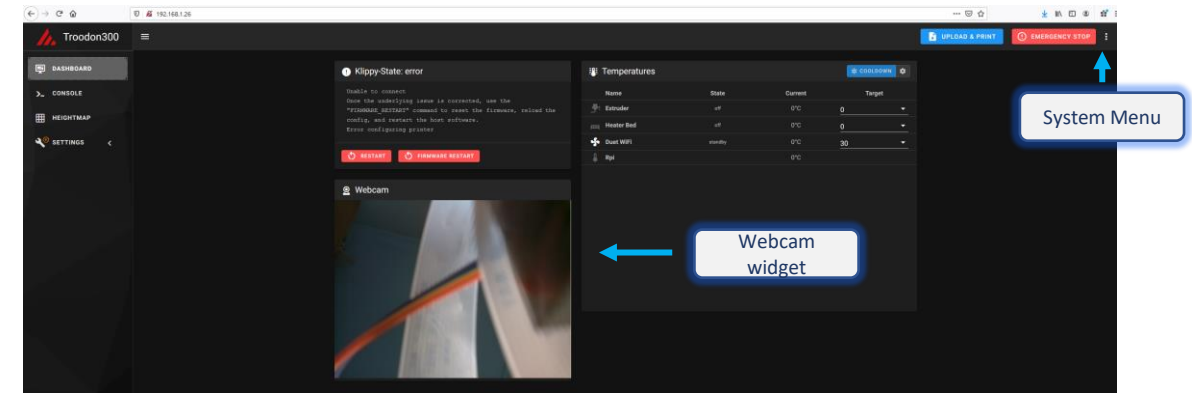

Diagram 1.4

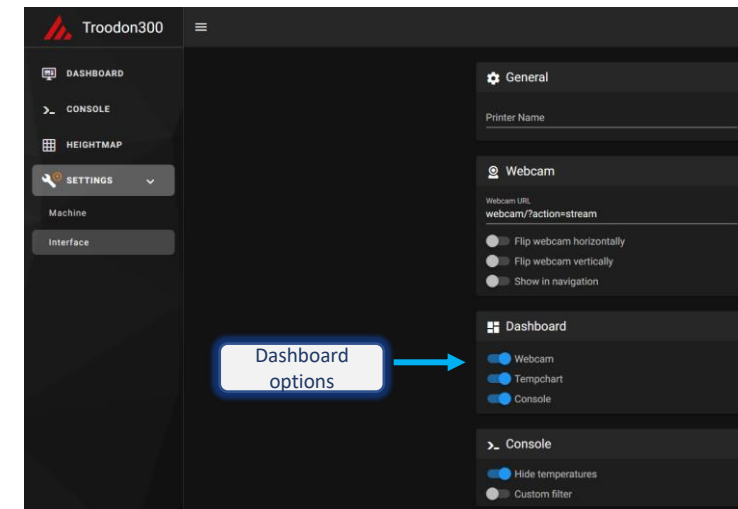
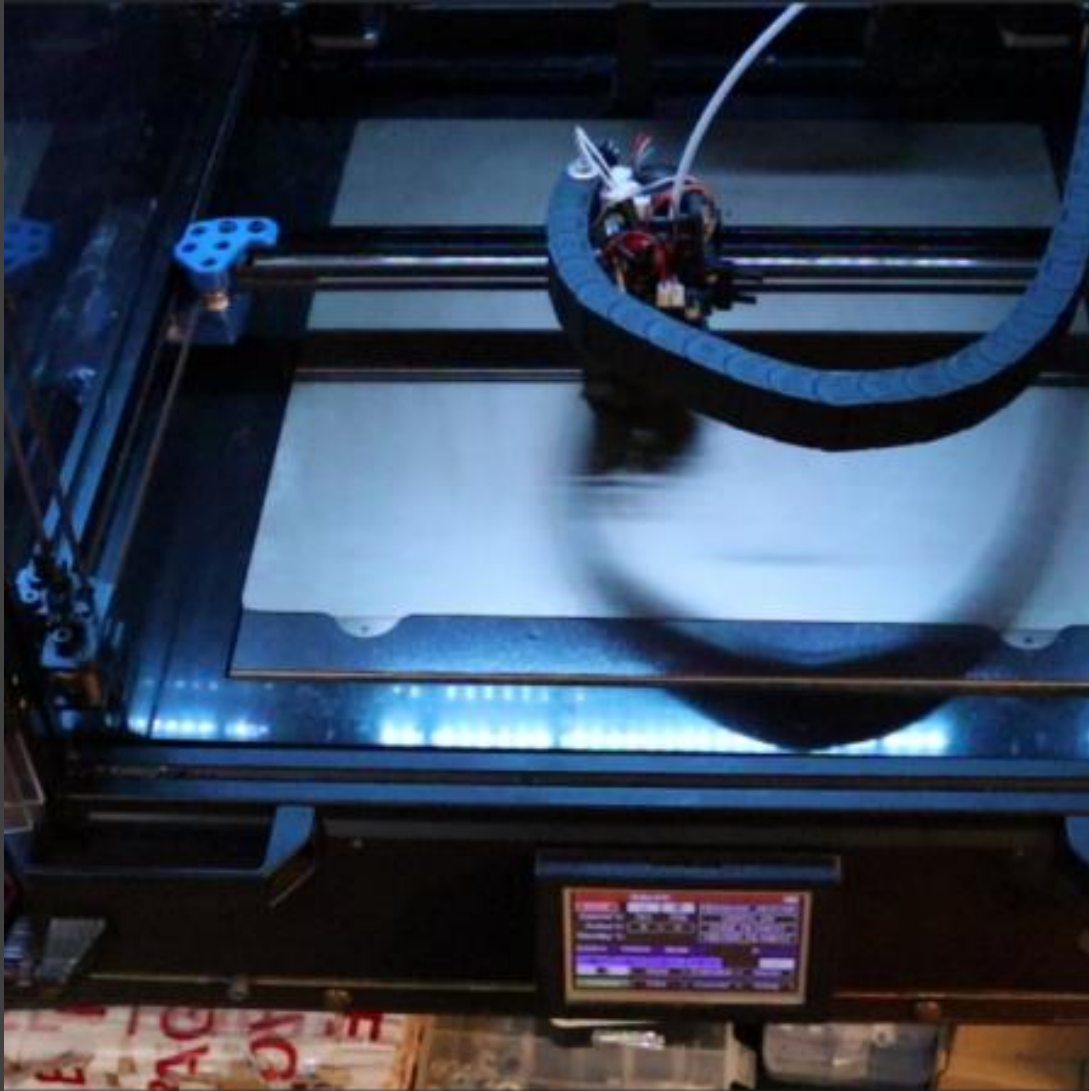

Diagram 1.5



Step 2.
Connect Raspberry PI to the
Printer

2.a – 2.b: Open the printer and connect Panel Due

a. Open the printer.

Open the front panel of the printer to access the electronics and locate the Panel Due board ([Diagram 2.1](#)), which is located on the front panel of the printer. Loosen screws holding the front panel – **please note that the screws should not be removed completely as they are secured with T-nuts**. Just loosen the screws enough to turn the T-nuts (you may need to slightly push the panel in and turn the screw back and forward one more time to have T-nuts released). Now remove the panel carefully (so cables connecting it to the rest of Troodon electronics are not damaged or disconnected) and lay it flat on a steady horizontal surface (e.g., on a table).



These steps should be done strictly with the printer powered off and disconnected from the main power.

b. Connect Panel Due harness.

Locate Panel Due board connector and connected Panel Due cable on the Panel Due board and mark the top left pin on both the cable and connector while they are still connected ([Diagram 2.2](#)). Top left refers to the pin in the top row on the side closest to the printer, as highlighted with the red arrow on the [Diagrams 2.2 and 2.3](#) (when you disconnect the cable it will be on the right side of the cable when facing you as per the diagram). From now on the target pin on the Panel Due cable will be referred as “top right pin” and the target pin on the Panel Due board connector as “top left pin”. Now disconnect the cable from the connector by first pulling two retaining tabs to the side

On your Panel Due harness (attached to the RASPI in Step 1) locate the Power connector – the one with two male pins. One of these pins is marked with a triangle/arrow – connect it to the Panel Due cable so that this pin is connected to the top right pin of the Panel Due cable (highlighted with the green arrow on [Diagrams 2.2 and 2.3](#)).

Now locate the Data Connector of your RASPI Panel Due harness and the pin on it that is marked with triangle/arrow. Connect it to the Panel Due board connector on the printer Panel Due board (where the cable used to be connected) so that the harness pin marked with arrow/triangle goes to the top left pin of the Panel Due board connector (highlighted with the red arrow on [Diagrams 2.2 and 2.3](#)).



[Diagram 2.3](#) illustrates the end result of these steps.

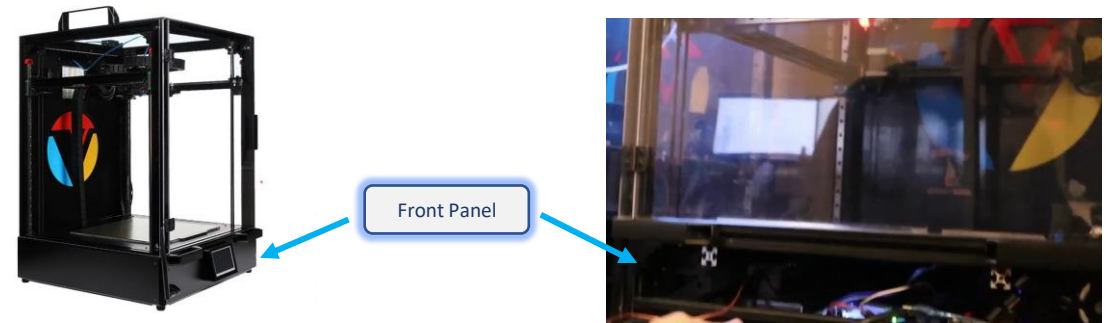

Diagram 2.1

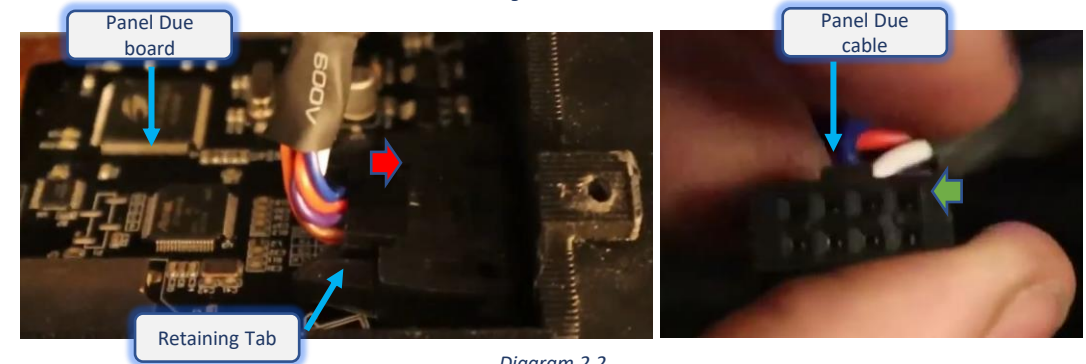

Diagram 2.2

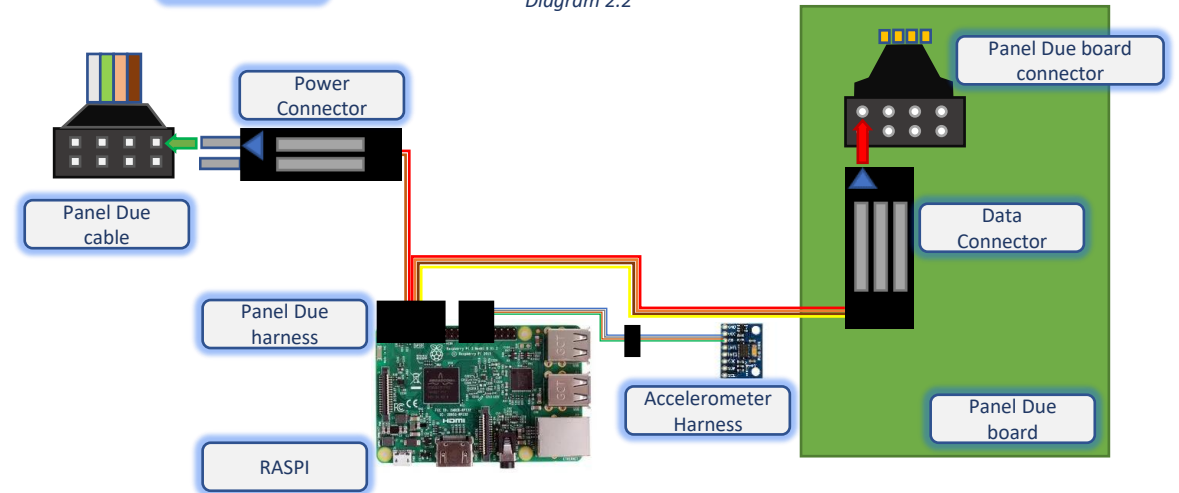

Diagram 2.3

2.c: Connect RASPI to the mainboard

c. Connect RASPI to the mainboard.

Insert one end of the USB cable into one of the USB ports on RASPI and another end into the USB port on your printer mainboard (Diagram 2.4).

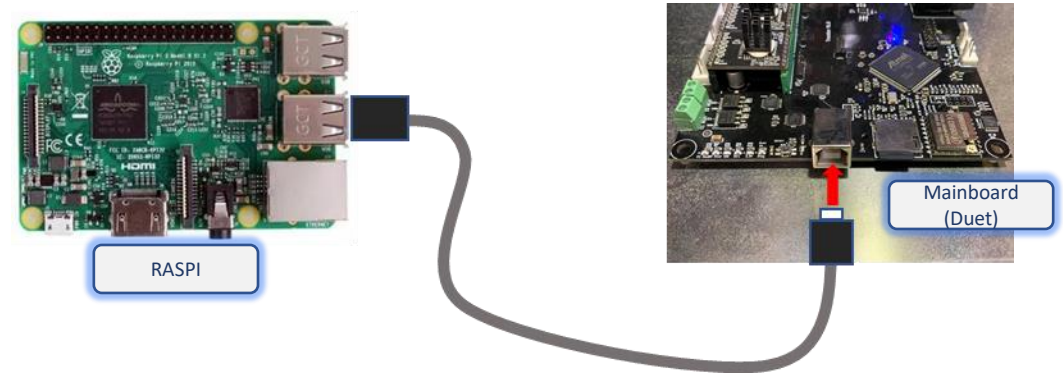

Diagram 2.4

```
pi@Troodon300: ~/klipper
(Top)
Klipper Firmware Configuration
[ ] Enable extra low-level configuration options
  Micro-controller Architecture (SAM3/SAM4 (Due and Duet)) --->
  Processor model (SAM4e8e (Duet Wifi/Eth)) --->
[*] Use USB for communication (instead of serial) (NEW)

Quit
Save configuration?
(Y)es (N)o (C)ancel

[Space/Enter] Toggle/enter      [?] Help      [/] Search
[Q] Quit (prompts for save)     [ESC] Leave menu
```

Step 3. Configure Klipper

3.a – 3.b: Power Up and connect

a. Power up printer and reset printer mainboard.

Power on your printer. Ensure that RASPI receives power from the harness and booted up properly (you should be able to access it via web interface as described in Step 1.f)



The display panel of your printer should now be working (Diagram 3.1).

Now access the printer mainboard (Duet WiFi clone) and locate two erase pins on it (highlighted with red circle on Diagram 3.2) and reset button (small button near the USB port highlighted with green circle on Diagram 3.2). With printer still powered on, shorten two erase pins by connecting them with tweezers, a screwdriver or a jumper connector (if available). Wait for 3 seconds, remove screwdriver or jumper and press (tap) the reset button.

b. Prepare printer mainboard for flashing.

This step is performed by sending commands to your RASPI via SSH (command line interface). Please login to RASPI via SSH from your PC using “ssh” command on Windows, ssh client like Putty or Terminal program on Mac and IP address or host name as determined in Step 1.f (e.g., 192.168.1.26 or Troodon300):

```
C:\> ssh pi@192.168.1.26
```

If this is the 1st SSH session with RASPI you may get a security warning (Diagram 3.3) please confirm by typing yes and then <Enter>. The default password for RASPI is **raspberry**, please consider changing it when the installation is finished.

```
pi@Troodon300:~$ cd klipper
```

Next step is to detect an id of connected printer mainboard – ensure that only the printer mainboard is

```
pi@Troodon300:~$ ls /dev/serial/by-id/*
```

The response from the command (USB id of the printer mainboard) should be in the following format (actual

```
/dev/serial/by-id/usb-03ab-6124-if00
```

Please record this id somewhere as it will be used in the next step.



Please note that is the id above contains word “Duet” then the mainboard has not been properly reset, please go back to Step 3.a. If you get ‘No such file or directory’ error, check the USB connection between RASPI and the mainboard.

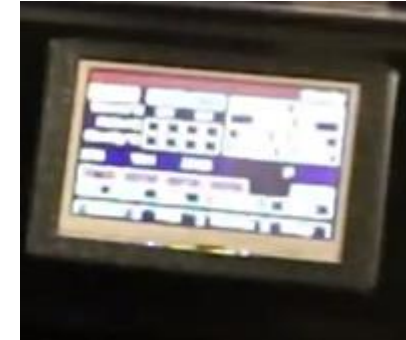

Diagram 3.1

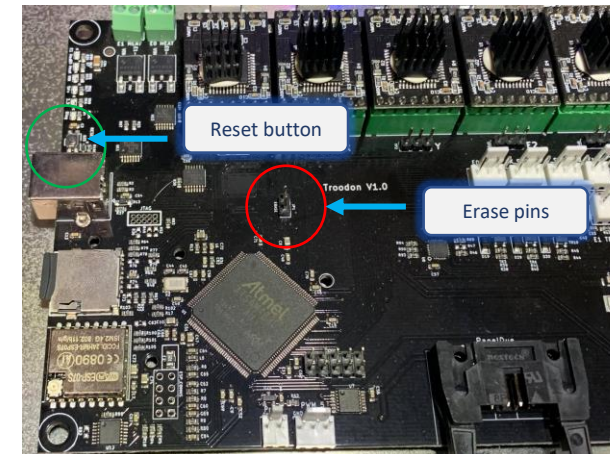

Diagram 3.2

```
C:\> Command Prompt - ssh pi@Troodon300
Microsoft Windows [Version 10.0.19042.804]
(c) 2020 Microsoft Corporation. All rights reserved.

C:\Users\Alex>ssh pi@Troodon300
The authenticity of host 'troodon300 (2001:44b8:314d:1c00:afc0:39f4:85ed:9818)' can't be established.
ECDSA key fingerprint is SHA256:xkg1fY08x1NFJMd7CT+LbYwhu6cozZKftPZ3NdFDzrg.
Are you sure you want to continue connecting (yes/no)?
```

Diagram 3.3

3.c: Prepare mainboard firmware

c. Prepare mainboard firmware.

Continuing the same SSH session (established as part of Step 3.b) enter the command to stop klipper service:

```
pi@Troodon300:~$ sudo service klipper stop
```

As this is the first time sudo command is used (for this session), it will ask you for password (**raspberr**y).

Now enter the following command:

```
pi@Troodon300:~$ make menuconfig
```

This will bring up the Klipper Firmware Configuration menu ([Diagram 3.4](#)). Please select the “Micro-controller Architecture” menu (current selection will be “Linux process”) and press Enter. In the next menu that appears on the screen please select “SAM3/SAM4 (Due and Duet)” and press Enter ([Diagram 3.5](#)).

Now as your Micro- Micro-controller Architecture is set properly, select the “Processor model” menu, press Enter, then select “SAM4e8e (Duet Wifi/Eth)” and press Enter ([Diagram 3.5](#)).

Go back to the main menu, ensure that please ensure that “Use USB for communication...” option is active (highlighted with [*]) and press ESC. You will be prompted to save the configuration ([Diagram 3.7](#)), please confirm by pressing Y (Yes). This will return you back to your SSH session.

After that, the firmware for your printer mainboard (klipper.bin) needs to be compiled – please enter the following command

```
pi@Troodon300:~$ make
```

When the process finishes (it will indicate it is creating the **klipper.bin** file), the firmware is ready to be flashed to your printer mainboard.

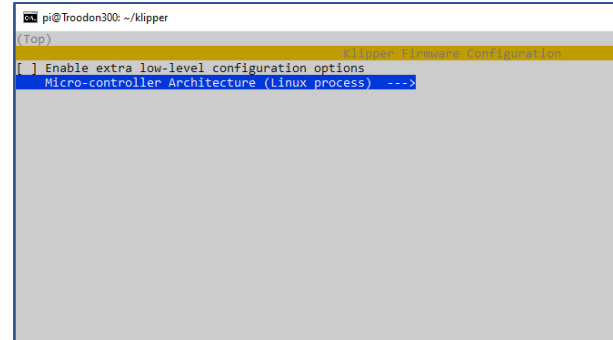

Diagram 3.4

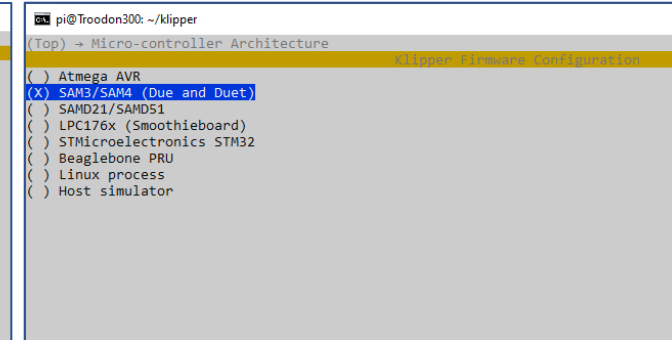

Diagram 3.5

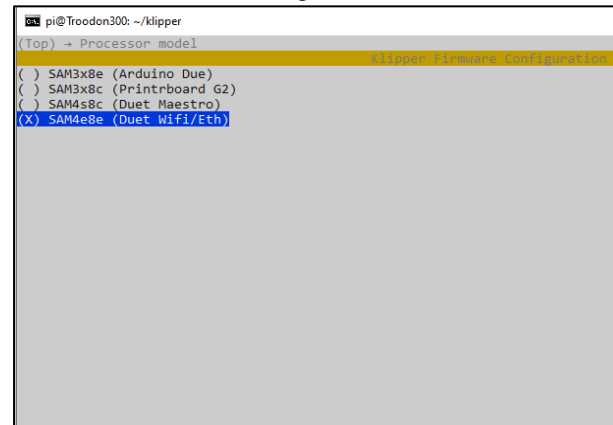

Diagram 3.6

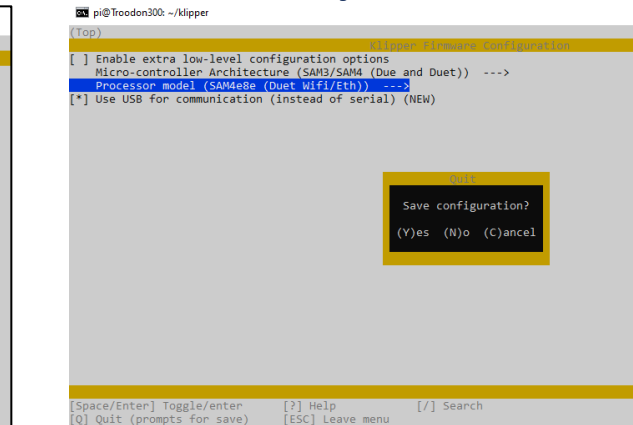

Diagram 3.7

3.d: Flash printer mainboard

d. Flash printer mainboard.

Continuing the same SSH session (established as part of Steps 3.b and 3.c) flash the mainboard firmware (precompiled as a part of Step 3.c), by entering the following command:

```
pi@Troodon300:~$ make flash FLASH_DEVICE=/dev/serial/by-id/usb-03ab-6124-if00
```



Note that FLASH_DEVICE needs to be in uppercase and the id you enter after the '=' sign should be exactly the id that was noted as part of Step 3.b (ideally this should be just copied and pasted if your terminal software supports copy & paste).

Check the output of the command, it should end with:

```
Verify successful  
Done in 0.575 seconds  
Device reconnect on /dev/serial/by-path/platform-....usb.....
```



If there is an error message, just repeat the last command (make flash FLASH_DEVICE=...).

After successful flashing enter the same command, that was used in Step 3.b:

```
pi@Troodon300:~$ ls /dev/serial/by-id/*
```

The response should be different this time, e.g. :

```
/dev/serial/by-id/usb-Klipper_sam4e8e_00313953324A46533037303431303034-if00
```



Please record this id as it will be required to establish the connection to the printer later on.

Finally, start klipper service by entering:

```
pi@Troodon300:~$ sudo service klipper start
```

3.e – 3.f: Configure printer connection

e. Configure printer connection.

Go to your Klipper (Mainsail) dashboard page in your web browser (as described in Step 1.f) and select “Settings” (on the left side menu), then “Machine” and then click the “printer.cfg” file in the “Config Files” widget (Diagram 3.8).

The file will be opened for editing, please locate the “[mcu]” section, which should have a single “serial” entry (Diagram 3.9).



Please ensure you are not editing the “[mcu rp1]” section at the top of the file.

Replace the value in the “serial:” entry with the id of your printer mainboard after it has been flashed with klipper firmware (Step 3.d) – it should be exactly as recorded, e.g.

serial: /dev/serial/by-id/usb-Klipper_sam4e8e_00313953324A46533037303431303034-if00

If possible, please use copy & paste command to ensure the correct id is entered. Please click “SAVE & RESTART” button in the top right corner of the web page.

After the restart, navigate to the Dashboard – you will likely see “Printer is not ready” message. In this case, please restart Moonraker by pressing System menu (the top right button labelled with 3 dots on the Dashboard page) and selecting “Restart Services - Moonraker”. You can also use the “Host – Reboot” command for a complete reboot.

You should have a printer connection (Diagram 3.10).

f) Create SD card backup.

Power off the printer, remove SD card from RASPI and create a backup copy of the card image using PC card reader and Win32DiskImager or similar.

Insert SD card back into the SD card slot of your RASPI.

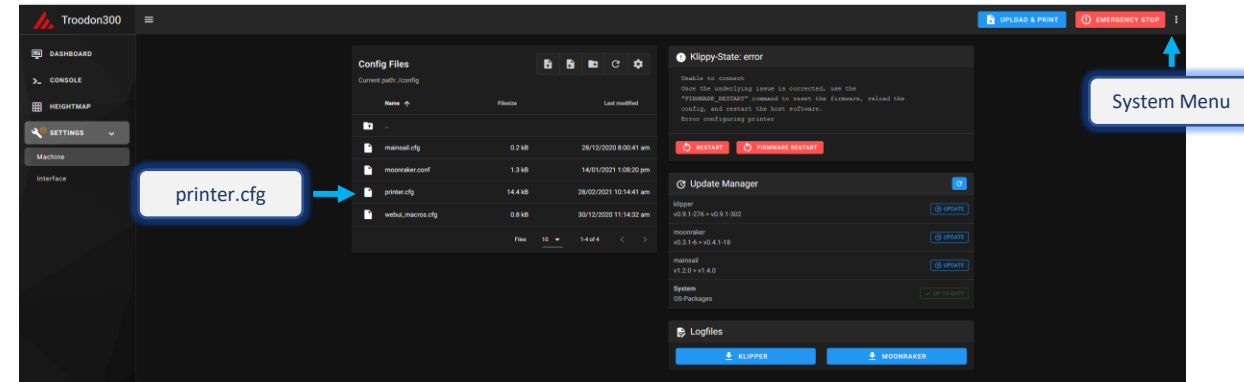

Diagram 3.8

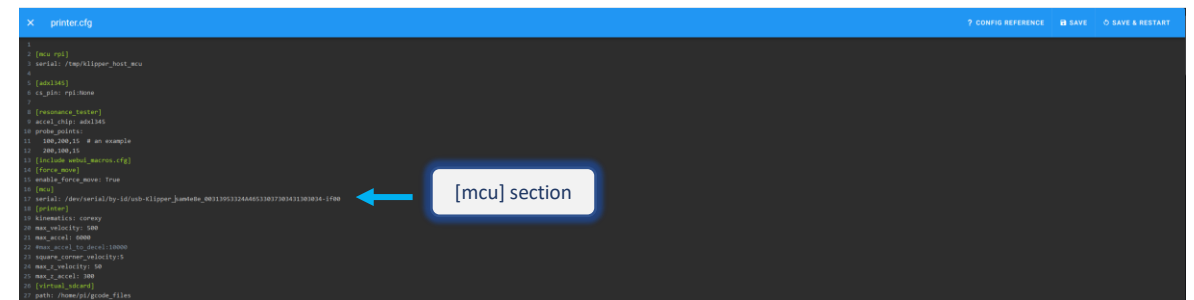

Diagram 3.9

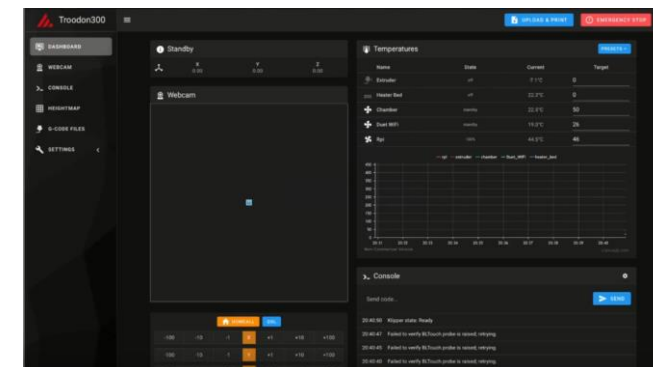

Diagram 3.10



Step 4.
Finalize Installation

4.a – 4.c: Wrapping up

a. Route cables.

Power off printer. Select the location where RASPI will be mounted within the electronics enclosure of the printer and temporarily place your RASPI there. Route accelerometer cables to the main printer enclosure so that the accelerometer board can be placed on the print head in the future. You may need to temporarily disconnect accelerometer harness from RASPI or (preferably) disconnect at the middle connector of the accelerometer harness to route the cable. Route the camera ribbon cable into the main enclosure of the printer. [Diagram 4.2](#) shows suggested camera location, 3d-printed camera mount is used.

b. Mount RASPI.

Securely mount RASPI in the electronics enclosure of your printer (near the Panel Due board). You can use a 3D printed RASPI mount or use two screws from the Pane Due mount as shown on [Diagram 4.2](#).

c. Close the front panel.

Close the front panel, please refer to Step 2.a for details.



Diagram 4.1

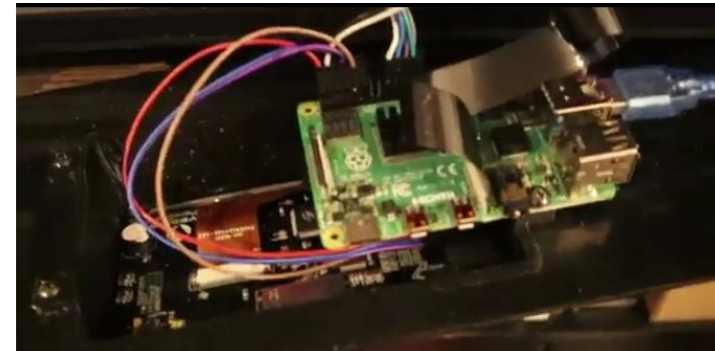

Diagram 4.2